



Identifying Sources of External PIM

Background:

Passive intermodulation (PIM) is a well-known problem in cellular systems. Downlink signals at the cell site mix at passive, non-linear junctions in the RF path, creating new signals. If these new signals (intermodulation products) fall in an operator's uplink band, they can elevate the noise floor and degrade system performance.

Factory PIM test equipment has been commercially available for over 20 years. RF equipment manufacturers use this equipment to verify that the components they produce are low PIM. Third order intermodulation product (IM3) levels below -107 dBm (-150 dBc) when tested using 2×43 dBm (20 W) test signals are commonly achieved. Field PIM test equipment was introduced approximately a decade later and is used to ensure that the completed cell site is low PIM. The field test not only verifies the condition of the RF components but also verifies that the installation crew applied proper workmanship techniques while assembling the site. IM3 levels below -100 dBm (-143 dBc) are often specified and achieved.

Even with low PIM components and perfect installation techniques a site can still exhibit very poor PIM performance due to PIM sources located beyond the antenna. In these instances, signals emitting from the antenna excite non-linear objects in the main beam of the antenna as well as non-linear objects in any direction within a few wavelengths of the antenna. These non-linear objects radiate or directly couple IM products back into the antenna system at surprisingly high levels. It is not uncommon for external PIM sources to generate IM3 as high as -50 dBm (-93 dBc) when measured at the system receiver!

External PIM is typically caused by loose metal-to-metal contacts. Some of these PIM sources are relatively easy to identify:

- Air handling equipment on the rooftop
- Overlapping layers of metal flashing
- Sheet metal cable trays
- Sheet metal roof vents
- Rusty metal objects

Other external PIM sources are not so obvious:

- Loose metal-to-metal connections hidden from view by roofing materials
- Loose cable hangers behind the antenna



In 2010 Anritsu announced, that it had invented and succeeded in developing a patented technology that pinpoints PIM faults called Distance-to-PIM™ (DTP). DTP shows the location for PIM problems within the antenna system, as well as distance to external PIM sources outside the antenna system. This was an incredible step forward in improving the quality of information received from the on-site PIM test. But one problem still remained for pinpointing external PIM beyond the antenna, DTP could tell you how far away from the antenna the PIM source was located, but not the angle. If the antenna had a 120° beamwidth, the PIM could be located anywhere along the 120° arc at the distance measured by DTP.

In addition, depending on the site configuration, there can be multiple PIM sources simultaneously in play, both in front of and behind the antenna. This is often the case on rooftop sites where the antennas are recessed from the edge of the building or hidden behind concealment panels to improve site aesthetics.

Tools are now available from Anritsu to help technicians determine the precise location of external PIM. Using the Anritsu PIM Hunter™ probe in conjunction with a spectrum analyzer, technicians can use traditional interference hunting techniques to locate external PIM sources in the field. This document describes the test process as well as provides important guidelines to consider while testing.

The test process:

The process begins with a traditional field PIM test. A PIM analyzer such as the Anritsu MW82119B PIM Master™ is used to generate two high power CW test signals that are injected into the system under test. These signals travel through the antenna feed system and radiate any PIM sources in the RF path. PIM sources beyond the antenna act like point source radiators, sending IM product signals in all directions from the point of origin. These signals travel back in the direction of the antenna, through the antenna feed system and arrive at the PIM analyzer receiver. The magnitude of the third order intermodulation product frequency (IM3) is measured by the PIM analyzer and displayed.

If the PIM level is higher than desired, record this value, then estimate how far away the offending PIM source is from the antenna aperture. This can be determined by using the DTP / DTP overlay function of the PIM Master as described in application note 11410-00869. This function compares the distance between a PIM source placed on the antenna aperture to the actual PIM source(s) present at the site and reports the relative distance. Record this value. Armed with information you have an approximate starting distance to begin your external PIM hunt.

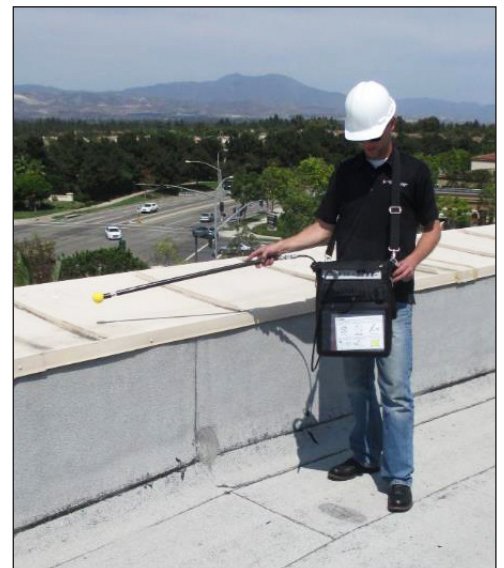
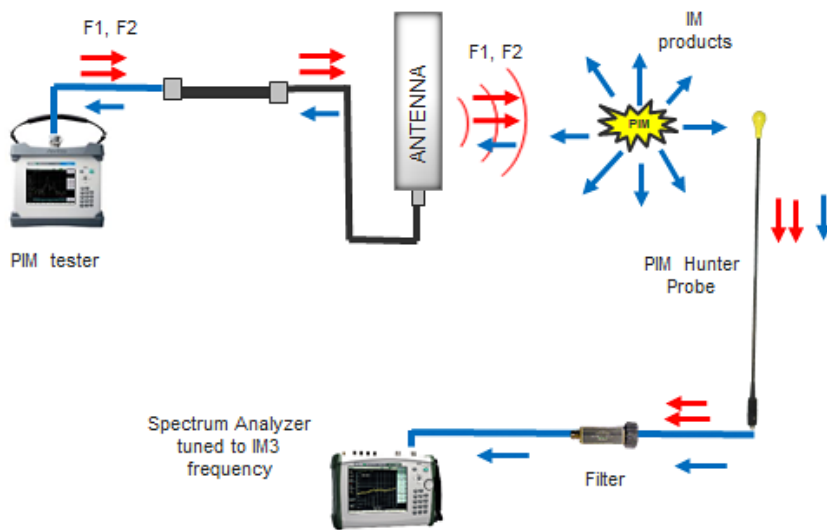
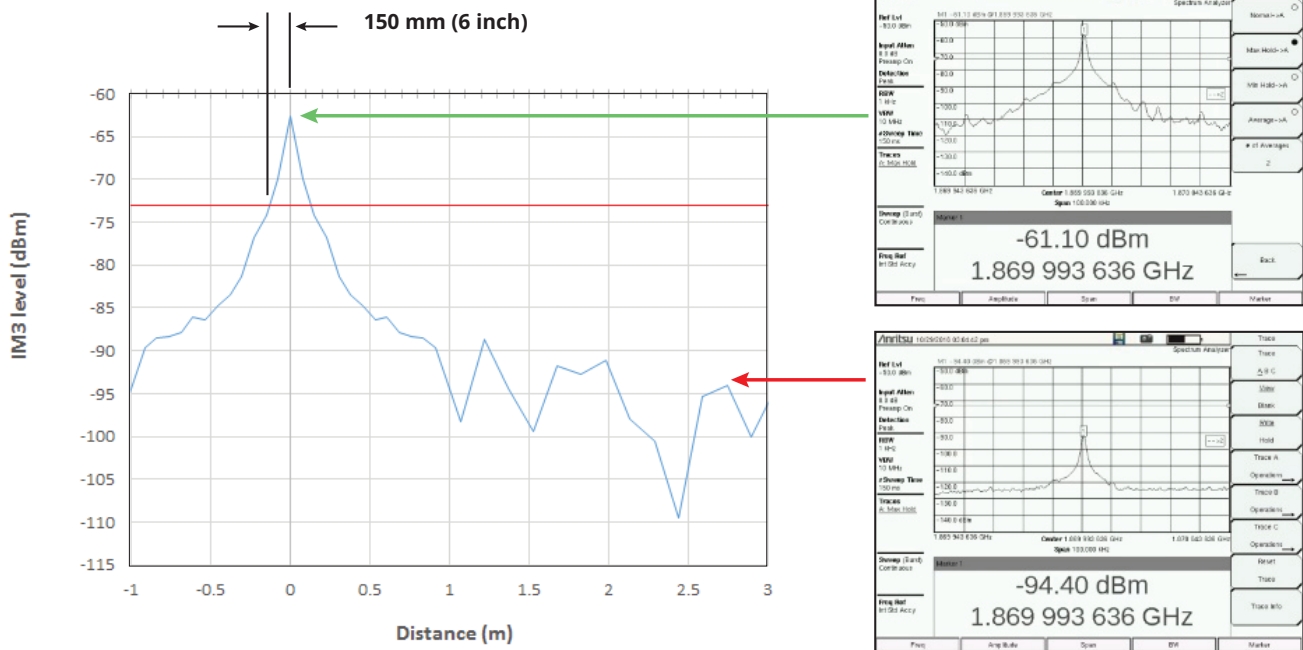

Photo credit: Vertical Limit Construction

Since the PIM analyzer uses two CW test signals to excite PIM sources in the system, the IM3 signal generated is also a CW signal. Connect the Anritsu PIM Hunter probe and an appropriate band-pass filter to the RF IN port of the spectrum analyzer and tune the spectrum analyzer center frequency to match the same IM3 frequency measured by the PIM analyzer. Set a Limit Line at approximately 10 dB lower than the IM3 level you are looking for and turn ON the Limit Alarm. Start the PIM analyzer to generate the high power test tones and begin hunting for external PIM sources. When the IM3 value measured on the spectrum analyzer increases above the limit line, the audible alarm sounds, meaning you are near a PIM source.



IM3 signal level vs. Distance from an external PIM source

As shown in the figure above, when the probe tip comes in close proximity to a PIM source, the IM3 value measured on the spectrum analyzer increases rapidly. When the probe tip is moved beyond the PIM source, the IM3 level decreases rapidly. The change in IM3 value is typically 10 dB within 150 mm (6 inches) from the PIM source. Move the probe tip back and forth in the area of interest until the maximum signal location is identified. Mark these spots with highly visible tape and continue hunting. Continue probing the field until all significant external PIM sources have been identified.

It is not uncommon for high signal variation to occur when the probe tip is far away from PIM sources. This is due to multipath fading of the IM3 signal from multiple PIM sources or from reflective surfaces at the site. Once close to a PIM source, the signal from that PIM source becomes dominant, reducing signal level variation.

Important considerations:

Safety: Care must be taken while hunting for external PIM sources to ensure that technicians performing the test are not exposed to RF fields in excess of the local jurisdiction’s maximum allowable occupational exposure limit. In the United States, the Federal Communications Commission (FCC) occupational / controlled exposure limits between 300 MHz and 10 GHz are shown in the table below. As a wireless professional working near antennas, it is important to know your local exposure requirements and maintain safe working distances. Safe working distances can be calculated for various site configurations using the equations provided below.

Frequency	Occupational / Controlled Exposure (mW/cm ²)
300 MHz to 1500 MHz	F (MHz) / 300
1500 MHz to 100,000 MHz	5

Calculations / Conversions:

$EIRP_{dBm} = \text{Test power (dBm)} + 3 \text{ dB} + \text{Antenna gain (dBi)} - \text{Direction adjustment (dB)} - \text{Cable loss (dB)}$
 (3 dB is added above because two high power test tones are present)

$EIRPW = (10^{(EIRP_{dBm} / 10)} / 1000)$

$MPE (W/m^2) = MPE (mW/cm^2) * 10$

$\text{Safe Distance} = \text{SQRT} (EIRPW / (4\pi * MPE (W/m^2)))$

Definitions:

$EIRP_{dBm}$ = Effective Isotropic Radiated Power in dBm

$EIRPW$ = Effective Isotropic Radiated Power in Watts

$MPE (W/m^2)$ = Maximum Permissible Exposure in W/m²

$MPE (mW/cm^2)$ = Maximum Permissible Exposure in mW/cm²

Direction adjustment = Front-to-Side ratio or Front-to-Back ratio based on the antenna pattern

Safe Distance = Distance from antenna where MPE is achieved

Using the FCC limits and assuming test cable loss = 0.5 dB, Front-to-side ratio = 15 dB and Front-to-back ratio = 25 dB for 65° Panel Antenna, the following safe working distances can be calculated:

Antenna type	Frequency	Gain (dBi)	Test power (dBm)	Distance (front)	Distance (side)	Distance (rear)
65° Panel Antenna	700 – 900 MHz	15.5	43	2.0 m	0.4 m	0.1 m
65° Panel Antenna	1700 – 2100 MHz	17.5	43	1.8 m	0.3 m	0.1 m
Omni Antenna	700 – 900 MHz	12.0	43	1.3 m	N/A	N/A
Omni Antenna	1700 – 2100 MHz	12.0	43	0.9 m	N/A	N/A
Small Omni Antenna	700 – 900 MHz	3.5	37	0.3 m	N/A	N/A
Small Omni Antenna	1700 – 2100 MHz	5.0	37	0.2 m	N/A	N/A

Clearly it is important to be aware of these safe working distances while hunting for external PIM. The PIM Hunter probe is approximately 1m in length, allowing you to probe locations near antennas while remaining in compliance with occupational exposure limits. If it becomes necessary to probe areas close to the front of an antenna, do so with your body behind or beside the antenna.

Band-pass filters: One of the worst PIM sources at the cell site is the receiver on your spectrum analyzer! If the high power test tones used to excite external PIM sources are able to reach the receiver front end, extremely high PIM levels will be generated within the spectrum analyzer itself. To prevent this, a high quality bandpass filter must be installed between the PIM Hunter probe and the input port of the spectrum analyzer. This filter must allow the IM3 signal of interest to pass while attenuating the two high power test signals generated by the PIM analyzer. The same filters available for use with the Anritsu MA2700A Interference Hunter™ work well for this application. See Technical Datasheet 11410-00719 for available filters.



Band-pass filter with plastic case removed

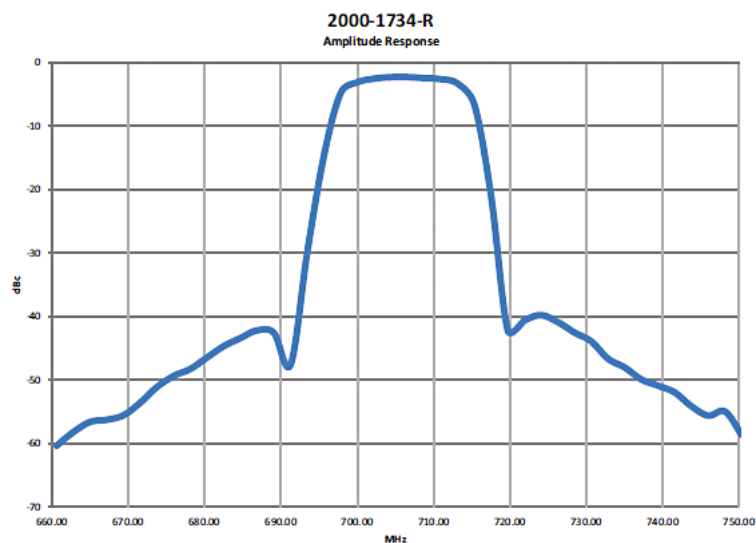

Spectrum Analyzer Settings: The spectrum analyzer settings below provide a good starting point for an external PIM hunt. Refer to your spectrum analyzer user guide for instructions for setting the following parameters.

- Center frequency = IM3 frequency from PIM analyzer
- Span = 100 kHz
- Amplitude reference level = 20 dB higher than peak IM3 measured on PIM Master
- Scale = 10 dB/div
- Auto Atten = ON
- Auto RBW = ON
- Auto VBW = ON
- Pre-amp = ON
- Trace A Operations = Average →A
- # of averages = 2
- Trace B Operations = Max hold →B
- Sweep Mode = Burst Detect
- Upper Limit = ON
- Limit level = 10 dB lower than peak IM3 measured on PIM Master
- Limit Alarm = ON
- Volume = set to maximum (found in the system menu)

The MW82119B PIM Master pulses the CW PIM test signals on and off continuously during the PIM test to reduce battery consumption. As a result, the IM3 signal you are hunting is also a pulsed signal. A spectrum analyzer equipped with burst detect, such as the MS2720T, is recommended to effectively capture the pulsing IM3 signal. Averaging 2 or 3 sweeps smooths the resulting magnitude while maintaining quick response to changes in PIM level.

In most cases, the IM3 signal you are seeking will be relatively high level signal (-50 dBm to -80 dBm). With the above settings, the noise floor of the spectrum analyzer should be well below -100 dBm. As soon as the PIM Analyzer is turned on, the IM3 signal should appear on the spectrum analyzer. When the PIM Hunter probe tip is located close to the PIM source, the level will increase rapidly.

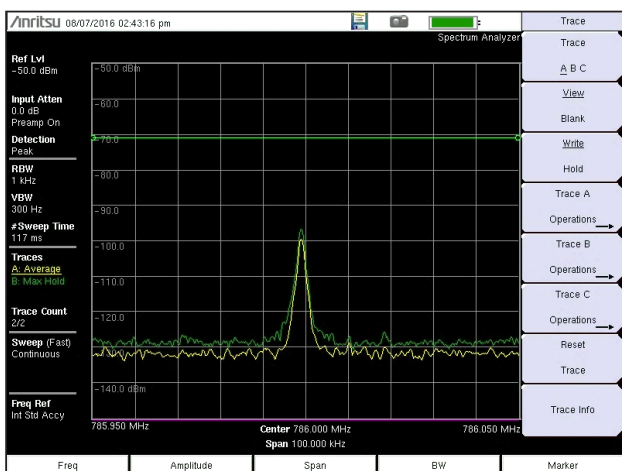

IM3 level seen when away from a PIM source

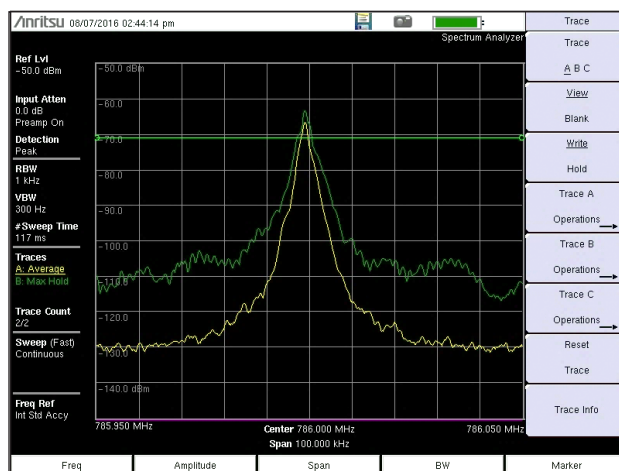

IM3 level seen when near a PIM source

Use the limit alarm feature of the spectrum analyzer to provide an audible alarm only when the probe tip is near a PIM source. This allows the operator “listen for PIM sources” rather than having to constantly focus on the spectrum analyzer display. Adjust the limit level up or down as required to only generate tones when the probe tip is within 0.25 meter of significant PIM sources.

Max hold on the B trace is useful for comparing the maximum IM3 level detected to the current IM3 level. If an audible alarm is heard while scanning across an area, slow down and scan the area more slowly looking for the location where the maximum occurred. Once a PIM source location is identified and marked, use the Reset Trace function to reset the maximum trace before hunting the next PIM source.

Be conscious of where you are standing: As it turns out, your body is a pretty good attenuator. If you stand between the antenna and a PIM source, the PIM level may reduce by >30 dB. While probing, be conscious of where the antenna is located and make sure the PIM Hunter probe tip is not being “shadowed” by your body.

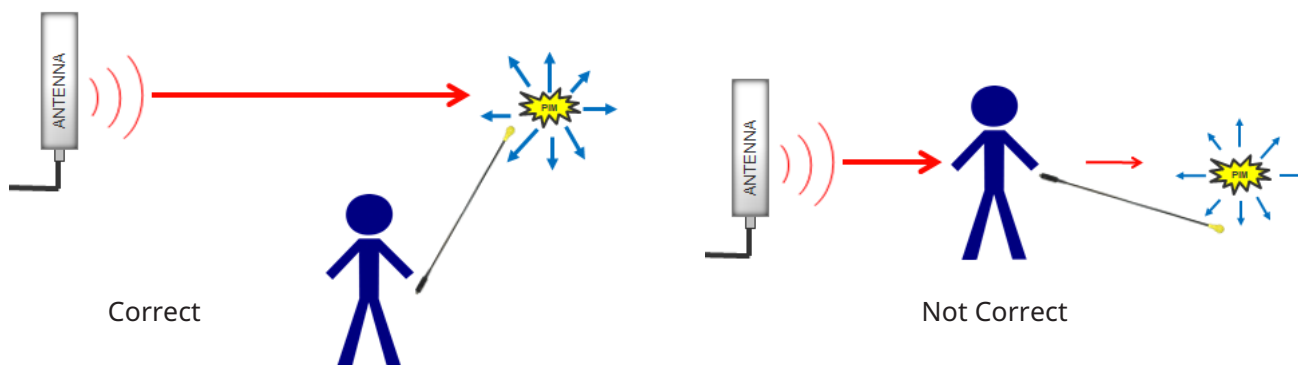

PIM is always high directly in front of the antenna: When probing screening walls or metal objects less than 1 wavelength in front of an antenna the CW test signals entering the probe will be significantly higher. Even with a high quality bandpass filter, the test tone levels may not be attenuated enough to prevent false PIM readings. Increasing the attenuation level on the spectrum analyzer and/or reducing the test power level on the PIM analyzer may improve results when testing near the face of the antenna.

PIM seems to be coming from everywhere: The external PIM hunting process works well if the PIM sources are truly external. If, however, the dominant PIM source is inside the antenna system, the antenna will spray the IM3 frequency into the environment. The radiated IM3 signal will bounce off of metal object in front of the antenna, causing just about everything to look like a PIM generator. In some cases, just holding the PIM Hunter probe in the air will generate a high PIM result. With experience, you will learn to recognize this effect and focus your attention back to the antenna rather than the environment..

PIM levels change dramatically and I am not moving the probe: At any given moment, the PIM Hunter system is detecting the vector sum of all PIM sources arriving at the probe tip. In some cases, there may be highly variable PIM source somewhere on the sector that is extremely sensitive to mechanical movement. Shifting your weight may cause a PIM source 3 meters away to increase in magnitude by 40 dB! The PIM Hunter probe will detect this increase, even if the probe is not directly over the source. Try standing as still as possible while moving the probe around to see if the signal level changes. For this same reason, it is highly recommended that only one person be moving on the rooftop at a time while the PIM hunt is in progress.

Another thing to keep in mind is that the IM3 frequency you are measuring may also be in use by mobiles attempting to communicate with the cell site. If you see short, bursty signals that raise the noise floor across the full 100 kHz bandwidth of the display, you are likely seeing live traffic. If the signal level from mobiles persists, change your test settings on both the PIM analyzer and the spectrum analyzer to move the IM3 frequency to unused spectrum.

Correcting the PIM problems after identification

In some cases, external PIM sources can be easily repaired on the first PIM hunting visit to a site. Examples might include removing rust and applying a fresh coat of paint to steel objects, tightening mounting hardware or wrapping metal objects in RF absorbing foam to attenuate the PIM.

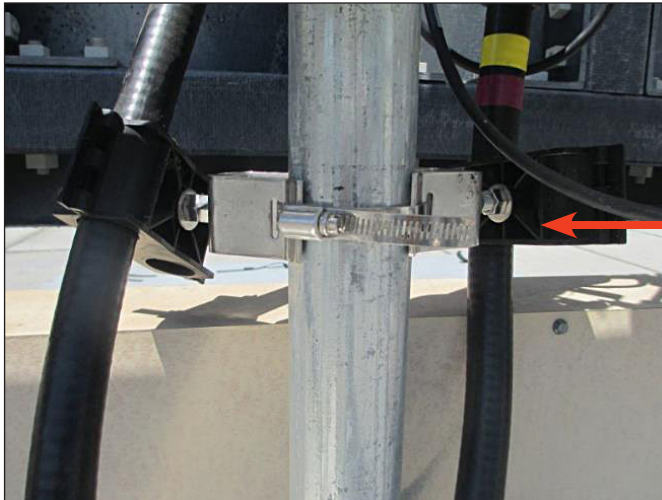

PIM reduced 15 dB by tightening hardware below the antenna

In other cases, more complex repairs might be required that cannot be resolved in a single visit. A typical example might be unseen metal-to-metal contacts below the roofing material surface that need repair. In these situations, it is desirable to clearly document the areas of concern and deploy temporary “fixes” to determine the performance benefits that could be gained by a permanent repair. Temporary fixes in use today include deploying PIM Blankets or RF absorbing foam over the PIM sources identified during the PIM hunt. PIM Blankets are available from manufactures such as ConcealFab Corp. (www.concealfab.com) and RF absorbing foam is available from manufactures such as Cuming Microwave (www.cumingmicrowave.com).



PIM Blankets deployed over large area generating PIM



RF absorber placed over small area generating PIM

The PIM analyzer serves multiple purposes in the external PIM identification and remediation process. It first acts as the high power signal source enabling the PIM Hunter to precisely identify external PIM locations. It also performs the pass / fail measurement necessary to document whether or not fixes, both permanent as well as temporary, will meet system requirements.

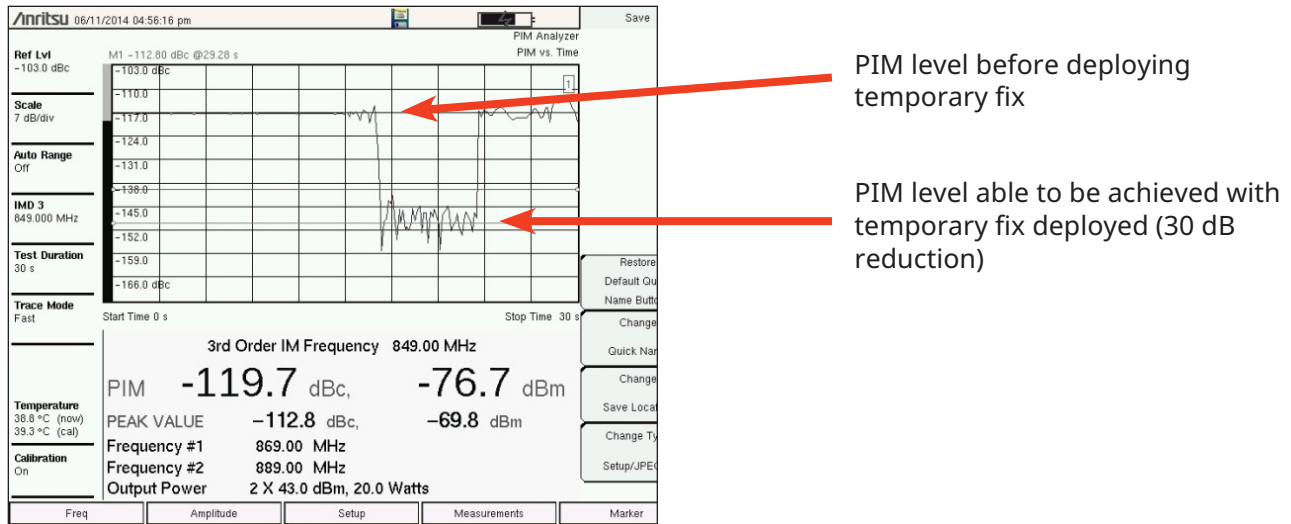

Conclusion:

Identifying the location of external PIM sources has been an extremely difficult problem for mobile operators worldwide. With Anritsu's PIM Hunter™, PIM Master™ and Spectrum Master™ products, operators finally have the tool set required to precisely identify external PIM sources. Once identified, a variety of PIM mitigation techniques can be deployed to reduce PIM levels and improve system performance.

• United States**Anritsu Company**

1155 East Collins Boulevard, Suite 100,
Richardson, TX, 75081 U.S.A.
Toll Free: 1-800-267-4878
Phone: +1-972-644-1777
Fax: +1-972-671-1877

• Canada**Anritsu Electronics Ltd.**

700 Silver Seven Road, Suite 120,
Kanata, Ontario K2V 1C3, Canada
Phone: +1-613-591-2003
Fax: +1-613-591-1006

• Brazil**Anritsu Eletrônica Ltda.**

Praça Amadeu Amaral, 27 - 1 Andar
01327-010 - Bela Vista - Sao Paulo - SP - Brazil
Phone: +55-11-3283-2511
Fax: +55-11-3288-6940

• Mexico**Anritsu Company, S.A. de C.V.**

Av. Ejército Nacional No. 579 Piso 9, Col. Granada
11520 México, D.F., México
Phone: +52-55-1101-2370
Fax: +52-55-5254-3147

• United Kingdom**Anritsu EMEA Ltd.**

200 Capability Green, Luton, Bedfordshire LU1 3LU, U.K.
Phone: +44-1582-433280
Fax: +44-1582-731303

• France**Anritsu S.A.**

12 avenue du Québec, Batiment Iris 1-Silic 612,
91140 Villebon-sur-Yvette, France
Phone: +33-1-60-92-15-50
Fax: +33-1-64-46-10-65

• Germany**Anritsu GmbH**

Nemetschek Haus, Konrad-Zuse-Platz 1
81829 München, Germany
Phone: +49-89-442308-0
Fax: +49-89-442308-55

• Italy**Anritsu S.r.l.**

Via Elio Vittorini 129, 00144 Roma Italy
Phone: +39-06-509-9711
Fax: +39-06-502-2425

• Sweden**Anritsu AB**

Kistagången 20B, 164 40 KISTA, Sweden
Phone: +46-8-534-707-00
Fax: +46-8-534-707-30

• Finland**Anritsu AB**

Teknobulevardi 3-5, FI-01530 VANTAA, Finland
Phone: +358-20-741-8100
Fax: +358-20-741-8111

• Denmark**Anritsu A/S**

Kay Fiskers Plads 9, 2300 Copenhagen S, Denmark
Phone: +45-7211-2200
Fax: +45-7211-2210

• Russia**Anritsu EMEA Ltd.****Representation Office in Russia**

Tverskaya str. 16/2, bld. 1, 7th floor.
Moscow, 125009, Russia
Phone: +7-495-363-1694
Fax: +7-495-935-8962

• Spain**Anritsu EMEA Ltd.****Representation Office in Spain**

Edificio Cuzco IV, Po. de la Castellana, 141, Pta. 5
28046, Madrid, Spain
Phone: +34-915-726-761
Fax: +34-915-726-621

• United Arab Emirates**Anritsu EMEA Ltd.****Dubai Liaison Office**

P O Box 500413 - Dubai Internet City
Al Thuraya Building, Tower 1, Suite 701, 7th floor
Dubai, United Arab Emirates
Phone: +971-4-3670352
Fax: +971-4-3688460

• India**Anritsu India Pvt Ltd.**

2nd & 3rd Floor, #837/1, Binnamangla 1st Stage,
Indiranagar, 100ft Road, Bangalore - 560038, India
Phone: +91-80-4058-1300
Fax: +91-80-4058-1301

• Singapore**Anritsu Pte. Ltd.**

11 Chang Charn Road, #04-01, Shriro House
Singapore 159640
Phone: +65-6282-2400
Fax: +65-6282-2533

• P. R. China (Shanghai)**Anritsu (China) Co., Ltd.**

27th Floor, Tower A,
New Caohejing International Business Center
No. 391 Gui Ping Road Shanghai, Xu Hui Di District,
Shanghai 200233, P.R. China
Phone: +86-21-6237-0898
Fax: +86-21-6237-0899

• P. R. China (Hong Kong)**Anritsu Company Ltd.**

Unit 1006-7, 10/F., Greenfield Tower, Concordia Plaza,
No. 1 Science Museum Road, Tsim Sha Tsui East,
Kowloon, Hong Kong, P. R. China
Phone: +852-2301-4980
Fax: +852-2301-3545

• Japan**Anritsu Corporation**

8-5, Tamura-cho, Atsugi-shi,
Kanagawa, 243-0016 Japan
Phone: +81-46-296-6509
Fax: +81-46-225-8359

• Korea**Anritsu Corporation, Ltd.**

5FL, 235 Pangyoyeok-ro, Bundang-gu, Seongnam-si,
Gyeonggi-do, 13494 Korea
Phone: +82-31-696-7750
Fax: +82-31-696-7751

• Australia**Anritsu Pty Ltd.**

Unit 20, 21-35 Ricketts Road,
Mount Waverley, Victoria 3149, Australia
Phone: +61-3-9558-8177
Fax: +61-3-9558-8255

• Taiwan**Anritsu Company Inc.**

7F, No. 316, Sec. 1, Neihu Rd., Taipei 114, Taiwan
Phone: +886-2-8751-1816
Fax: +886-2-8751-1817

